



Dirección: Av. Habilitación Urbana Municipal Mz. C Lt. 6 – PUCALLPA
Ruc: 20394044351, Oficina: 986 135 157, Correo electrónico: oficina.darosac@gmail.com



664-200-1

NAVAJA ELECTRICISTA MADERA

- Navaja de bolsillo para electricista
- Función pelacables
- Mango de madera



R	Icono	L mm	A mm	B
664-200-1	10	200	85	83

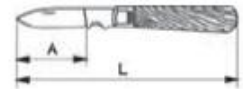

66-156-1

CUTTER

- Cutter cuchilla seccionable
- Medida 18x157 mm



R	Icono	L mm	B
666-156-1	12	157	106



475-50PH2-1

CAJA DE 5 PUNTAS PHILLIPS LARGAS 1/4"



- Cuadrado: 1/4" DIN 3126-C 6,3, ISO 1173
- Material: Aleación de acero de alto rendimiento
- Para uso general en industria
- Caja de plástico de 5 uds.

475-PH2-1

CAJA DE 10 PUNTAS PHILLIPS LARGAS 1/4"



- Cuadrado: 1/4" PH2-25MM
- Material: Aleación de acero de alto rendimiento
- Para uso general en industria
- Caja de plástico de 10 uds.



475A-60QR-1

PORTAPUNTAS 1/4" CON SISTEMA DE AJUSTE



- DIN 3126-E6.3, ISO1173
- DIN 3126 D 6,3
- Imán permanente
- Envase unitario para colgar

475A-M-75-1

ADAPTADOR MAGNETICO UNIVERSAL, 1/4" 75 M

- Cuadradillo: 1/4" DIN 3126-E 6,3, ISO 1173
- Fuerte imán
- DIN3126 D 6,3
- Envase unitario para colgar



982-TOR-1

NIVEL TORPEDO

- Imán en la base
- Adecuado para fontaneros
- 3 fiolas: horizontal, vertical y de 45°
- Precisión de 1mm / m en fiola horizontal
- Precisión de 1mm / m en fiola vertical
- Líquido de alta visibilidad en el interior de las fiolas.



Q		L mm	A mm	B mm	
982-TOR-1	1	230	15	40	80

5-200C-1

LLAVE AJUSTABLE

- Material: CrV
- Acabado: Cromado
- Dureza: 40-45 HRc
- Ángulo de cabeza 15° que proporciona mayor accesibilidad en espacios estrechos
- Normas: UNE16532, ISO6787, DIN3117



Q			A mm	B mm	D mm	E mm	L mm	
5-200C-1	5	200 mm - 8"	24	26	7,5	13,5	205	250
5-250C-1	5	250 mm - 10"	29	29,5	9	16	260	405
5-300C-1	5	300 mm - 12"	36	36	11	19	310	650

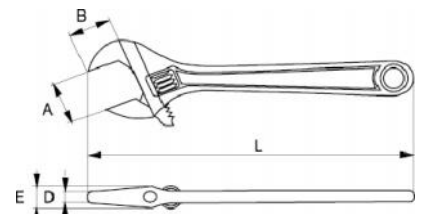

LLAVE MIXTA RACHET

- Aleación de acero de alto rendimiento
- Cromado acabado mate
- Dureza: 40-50 HRc

R	Icono	B1 mm	S mm	B2 mm	E mm	L mm	Icono
18-10-1	1	22	10	21,5	5,1	160	57
18-11-1	1	24,5	11	23,5	5,5	165	67
18-12-1	1	26	12	25	5,9	170	82
18-13-1	1	28	13	26,4	6,4	180	95
18-14-1	1	30,8	14	28	6,7	190	113
18-15-1	1	33	15	30	7,3	200	130
18-16-1	1	24,5	16	31	7,8	210	158
18-17-1	1	37	17	33	8	225	180
18-18-1	1	39,5	18	35	8,2	235	213
18-19-1	1	40,8	19	36	8,4	245	233
18-21-1	1	44,8	21	42	9	290	343

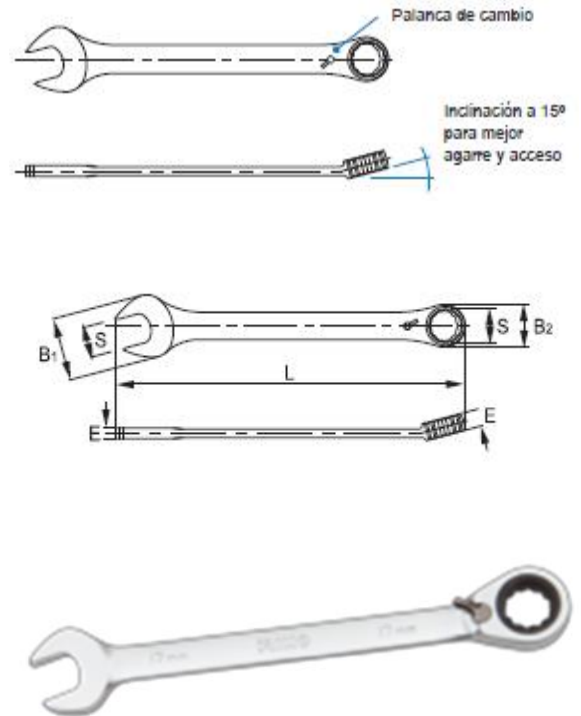

25-8-H

JUEGO 8 LLAVES MIXTAS 8-22MM

- Aleación de acero de alto rendimiento cromado acabado mate



R	Icono	Pzs.	Icono	Icono
25-8-H	1	8	250x120x50	875
25-08	8 mm	25-14	14 mm	
25-10	10 mm	25-17	17 mm	
25-11	11 mm	25-19	19 mm	
25-13	13 mm	25-22	22 mm	



LLAVES MIXTAS – PULGADAS

- Acabado cromo mate

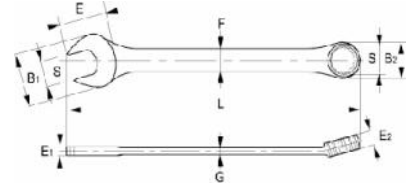

Q	Icon	S mm	L mm	b1 mm	b2 mm	F mm	E mm	e1 mm	e2 mm	G mm	g
25-08-1	1	8	119	18,8	13,6	6,8	9,9	4,0	6	3,3	21
25-09-1	1	9	124	21	15,1	7,9	10,4	4,0	6,8	3,4	26
25-10-1	1	10	134	22,8	16,2	8,6	10,7	4,8	7	3,6	38
25-11-1	1	11	143	25,8	17,1	9,1	12,6	4,8	7,5	3,6	39
25-12-1	1	12	154	27,8	18,9	10	13,2	5,2	8	4,2	51
25-13-1	1	13	164	29,8	20,2	11,5	14,6	5,2	8,3	4,2	63
25-14-1	1	14	174	29,8	21,2	11,4	15,8	5,8	8,9	4,6	68
25-15-1	1	15	183	34,1	22,3	12,2	16,9	5,8	8,9	4,6	85
25-16-1	1	16	194	35,1	23,8	13,2	17,6	6,3	9,5	5	107
25-17-1	1	17	203	37,2	25,3	14,4	18,6	6,3	10	5	118
25-18-1	1	18	214	39,2	26,8	14,4	20,5	6,7	10,5	5,2	137
25-19-1	1	19	228	41,4	28,3	15,8	21,1	7,0	11,2	5,2	163
25-21-1	1	21	249,5	45,4	32,4	17,3	22,8	8,6	12,6	6	210
25-22-1	1	22	249,5	45,4	32,4	17,3	22,8	8,6	12,2	6	202
25-24-1	1	24	270	49,7	36,1	20,3	25	9,2	13,6	6,4	276
25-25-1	1	25	289,5	53,4	39,6	22,5	27,6	9,6	14,2	6,8	346
25-27-1	1	27	310	58,4	41,6	23,3	29,5	10,0	14,6	7,2	382
25-28-1	1	28	310	58,4	41,6	23,3	29,5	10,0	14,6	7,2	402
25-29-1	1	29	330	60,4	45,6	23,3	32,1	10,6	15,6	7,6	476
25-30-1	1	30	330	60,4	45,6	23,3	32,1	10,6	15,6	7,6	468
25-32-1	1	32	349	67,4	48,8	25,3	35,6	11,2	17,8	8	567

Q	Icon	S mm	L mm	b1 mm	b2 mm	F mm	E mm	e1 mm	e2 mm	G mm	g
25A-08-1	1	1/4"	103	15,9	10,6	6,6	7,9	3,7	5,2	3	15
25A-10-1	1	5/16"	119	19	13,6	7,2	9,9	4	6	3,3	21
25A-12-1	1	3/8"	124	21,2	15,1	8,3	10,4	4	6,8	3,4	26
25A-16-1	1	1/2"	164	30	20,2	11,9	14,6	5,2	8,3	4,2	63
25A-18-1	1	9/16"	174	30	21,2	11,8	15,8	5,8	8,9	4,6	68
25A-20-1	1	5/8"	194	35,3	23,8	13,6	17,6	6,3	9,5	5	107
25A-22-1	1	11/16"	214	39,4	26,8	14,8	20,5	6,7	10,5	5,2	137
25A-24-1	1	3/4"	228	41,6	28,3	16,2	21,1	7	11,2	5,2	163
25A-26-1	1	13/16"	249,5	45,4	32,4	17,3	22,8	8,6	12,6	6	210
25A-28-1	1	7/8"	249,5	45,4	32,4	17,3	22,8	8,6	12,6	6	210
25A-30-1	1	15/16"	270	49,7	36,1	20,3	25	9,2	13,6	6,4	281
25A-32-1	1	1"	289,5	53,4	39,6	22,5	27,6	9,6	14,2	6,8	346
25A-34-1	1	1.1/16"	310	58,4	41,6	23,3	29,5	10	14,6	7,2	382
25A-36-1	1	1.1/8"	330	60,4	45,6	23,3	32,1	10,6	15,6	7,6	476
25A-40-1	1	1.1/4"	349	67,4	48,8	25,3	35,6	11,2	17,8	8	567

409 DESTORNILLADOR PTA PHILLIPS

- Mango: bi-componente con agujero para colgar Varilla: templada y cromada fabricada en acero de alto rendimiento
- Punta: con tratamiento anti corrosión para mayor adherencia
- Marcado: código y tamaño marcado por láser en varilla



Q	Icon	PH	mm	mm	mm	g
409-0-75	10	PH-0	75	90	165	35
409-1-100	10	PH-1	100	100	200	65
409-2-125	10	PH-2	125	110	235	100

Dirección: Av. Habilitación Urbana Municipal Mz. C Lt. 6 – PUCALLPA
 Ruc: 20394044351, Oficina: 986 135 157, Correo electrónico: oficina.darosac@gmail.com

408V -409V

DESTORNILLADOR AISLADO PTA PLANA - PHILLIPS

- Para trabajos en baja tensión hasta 1000V
- Mango: Bi-componente con agujero para colgar
- Varilla: aleación de acero de alto rendimiento, con recubrimiento aplicado directamente sobre la varilla.
- Punta negra protegida con mayor precisión

408V-5.5-125	10	1	5,5	125	100	225	65
409V-0-100	10	PH-0	100	90	190	40	
409V-2-175	10	PH-2	175	110	285	120	



45

JUEGO DE DESTORNILLADORES



45-4-B	1	4 piezas	2 planos / 2 Phillips	
45-6-B	1	6 piezas	3 planos / 3 Phillips	
45-9-B	1	9 piezas	5 planos / 4 Phillips	

121

DADO HEX. ENC 1/2

				S mm	A mm	B mm	C mm	L mm	
121-16-1				16	22,0	17,8	20,5	38,0	71
121-12-1				12	17,8	13,0	22,0	38,0	52
121-13-1				13	19,0	13,0	22,0	38,0	54
121-14-1				14	20,3	13,0	22,0	38,0	56
121-18-1				18	25,0	17,8	22,9	38,0	90
121-19-1				19	26,0	17,8	22,9	38,0	84
121-20-1				20	28,0	17,8	23,9	38,0	87
121-23-1				23	32,0	17,8	28,1	38,0	103
121-25-1				25	34,0	17,8	29,1	40,0	146
121-26-1				26	34,0	17,8	29,1	42,0	192

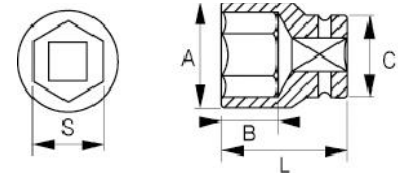

129-12-4

JUEGO DE VASOS 1/2" 12P



















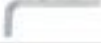









- Juego de vasos 12 piezas
- Vasos hexagonales, mm
- Acabado cromado brillante

129-12-4			8	12	330x100x50 1.600
121					10, 12, 13, 14, 16, 17, 19, 21, 22, 24 mm
125-70-1					
125-23-1					125 mm

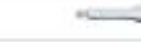

129-101-4

SET DADOS Y ACCESORIOS E 1/4"-1/2" 101P

Q	Icono	Part	Dim	Q	
129-101-4		1	101	380x280x80	7.000
101	○		4, 4.5, 5, 5.5, 6, 7, 8, 9, 10, 11, 12, 13, 14 mm		
121	○		8, 10, 12, 13, 14, 16, 17, 19, 20, 21, 22, 23, 24, 26, 27, 28, 30, 32 mm		
103	○		6, 7, 8, 10, 11, 12, 13, 14 mm		
124	○		13, 17, 19, 22 mm		
107-T	★		T8, T10, T15, T20, T25, T30		
107-H	●		3, 4, 5, 6 mm		
107-PH	+		PH-1, PH-2		
107-PZ	+		PZ-1, PZ-2		
107-SL	⊖		4, 5.5, 8 mm		
040	●		1.5, 2, 2.5 mm		
105-48-1			1/4" - 1/4"		
475-T	★		1/4" T 10, 15, 20, 25, 27, 30		
475-H	●		1/4" Hex 3, 4, 5 mm		
125-48-1			1/2" - 5/16"		
470-T	★		5/16" T 30, 40, 45, 50, 55, 60		
470-H	●		5/16" Hex 6, 7, 8, 10, 12, 14 mm		
470	⊖		5/16" SL8, 10, 12 mm		
105-70-1			125-70-1		
105-42-1			125-43-1		
105-50-1			105-28-1		
105-22-1			125-23-1		
2"			5"		
105-24-1			125-25-1		
4"			10"		
105-40-1			125-40-1		



129-23-4 SET DADOS Y ACCESORIOS ENC 1/2" 23P

R	Icono	Pzs.	Icono	Icono
129-23-4	1	23	320x250x75	3.500
121			8, 10, 12, 13, 14, 16, 17, 19, 20, 21, 22, 23, 24, 26, 27, 28, 30, 32 mm	
125-70-1				
125-25-1				250 mm
125-23-1				125 mm
125-40-1				
125-43-1				



302-260-2 LLAVE STILLSON

- Acero forjado
- Dentado de bocas templado a 55÷60 HRc
- Pintura epoxy de alta calidad

R	Icono	L	S	A mm	B mm	L mm	Icono
302-260-2	3	10"	1.3/8"	25	15	260	620
302-310-2	3	12"	1.3/4"	26	17	310	800

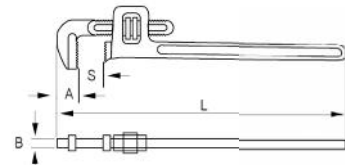

800-131-1 SERRUCHO DE COSTILLA



- Dentado universal, templado para un afilado duradero
- Mango atornillado de plástico

R	Icono	Icono	Icono	Icono	Icono
800-131-1	10	300	12	15/16	450